

Quick Setup Guide for IntelliAg Model YP1625 30" Twin Row Air Pro



The Quick Setup Guide assumes the Virtual Terminal, Master Switch, Working Set Master Module, Working Set Member Module, and all sensors have been connected and properly installed. Reference Operator's manual for installation instructions. **NOTE: The master switch is only required for hydraulic control systems. Reference the manual for instructions to assign a master switch as an auxiliary input.**

STEP 1: Pre-Programming Preparation:

1. Power on vehicle via ignition switch to activate Virtual Terminal (VT). Main menu will display pre-programmed default settings.
2. If errors are detected (e.g., failed sensors, incorrect configuration) an alarm and code displays. Alarms are silenced by pressing the Alarm Cancel button . Refer to Operator's manual for troubleshooting assistance.
3. The system has three user levels. The system loads in User Level 1 (operator level) at every power cycle. Access to User Level 2 and 3 screens to setup constants (system configuration) requires a password.

STEP 2: Change User Level to Dealer Level

To change the user level, a 6-digit password is required. Password includes the five-digit serial number found on the label of the Working Set Master or Information screen.

1. On the IntelliAg Main Work screen, press the Diagnostics button .
2. At the Diagnostics screen, press the Information button .
3. At the Information screen, record serial number of WSMT.
4. Press the Password button .
5. On the Password screen, enter the 6 digit password as follows: enter the first digit as 2 for User Level 2. For the next five digits, enter the Working Set Master serial number taken from the WSMT or Information screen.
6. Press the OK button . "Dealer screens on" appears at the bottom of screen confirming the password and dealer screens are activated.
7. Press the Work Screen button to return to the Main Work screen.

STEP 3: Auto Configuration (Identifies sensors connected to each module)

Auto config is performed at the factory, but may need to be done in the field as changes are made to the system or if options are added to the base planter.

1. Verify Auto Config results are correct. Check that the correct number of rows are assigned to the correct module and number of hopper sensors are assigned accurately.

To Run Auto Config:

1. Press the Next Page button until the Module Configuration button appears.
2. Press the Module Configuration button .
3. Press the AUTO CONFIG button .
4. Hour glass will indicate system is being configured detecting the presence of seed or hopper sensors connected to each module and will be automatically assigned to the appropriate module.
5. When Auto Config completes, press the Row Assign button to display the Row Assignment screen to verify correct Row # is assigned to the correct module based on serial number.
6. Enter # of rows assigned to each module.

Module Configuration Screen

SERIAL NUMBER	MODULE TYPE	MODULE ADDR.
10001	WSMB-POM	1
10002	WSMB-POM	2
10001	WSMB-18R	3
10001	WSMT-GP	4
10002	WSMB-18R	5
10001	WSMB-CFM	6

Seed Sensor Configuration Screen

MODULE ADDR.	TYPE	# OF ROWS	ROW #'s
1	WSMB-18R	16	1-16
2	WSMB-18R	16	17-32

STEP 4: Row Status/Row Width Setup

1. At the Row Assignment screen, press the Row I/O button .
2. Begin entering desired values using Table A as reference.
3. Press the Work Screen button when Row Status/Row Width configurations are complete to return to the Main Work screen.

STEP 5A: Material Configuration Setup (Controlled Hydraulic Drive)

15 different materials can be configured for use as planter controls. Reference the System Configuration section in the Operator's manual for additional information.

1. At the Main Menu screen, press the Control Setup button .
2. Select and press one of the Material buttons (Material 1-15).
3. Enter desired values from Table B.
4. Press the Control Setup button to return to the Control Setup screen.
5. Repeat steps 2-4 for additional materials.
6. Press the Channel Setup button to proceed to channel setup screen.

TABLE A: Row Status/Row Width Setup	Default Value or Value to Enter	Instructions/Definitions
Row Width	15"	Enter row width distance in inches to calculate seed rate correctly. NOTE: Using 15" planter in 30" mode should change On/Off Pattern to Every 2nd Row Off.
Auto Update Width	Enabled	When enabled, implement width will automatically calculate. If disabled, manually enter implement width.
On/Off Pattern	Every Row On	On/Off Pattern indicates specific row patterns to be on or off. Select pre-defined planter All Row On pattern. For other pre-defined planter patterns or individual row settings, reference Operator's manual.
Pop/Block Pattern	Every Row Population	Determines which sensors are used to calculate population and those used only for blockage detection. Select pre-defined Every Row Population. For other pre-defined patterns, reference Operator's manual.

TABLE B: Material Setup	Default Value/ Value to Enter	Controlled Hydraulic Drive Instructions/Definitions
Matrl Label	Matrl 1	Material Name can be customized to accurately define the material's type. Creating a name allows for quick identification at the Control Setup screen.
Type	Planter Control	Desired type of application control channel being used for a specific material. The Material Type must correctly match the Control Type to be able to select Material from the Material Summary screen and operate properly.
Units	Ks/Ac S/Sec	Automatically changes with the type of material application selected. Changes units for target application.
Preset Method	Enable	Enabled Preset Method allows 10 user-defined target rates to be adjusted from the Main Work screen using Inc or Dec buttons. A Disabled Preset Method increases/decreases the target rate based on the % values set at the Material Setup screen.
Seeds per Rev	See Manual	Set to number of seeds per 1 disc revolution.
Disc Low Limit	5	Set to desired min seed disc RPM.
Disc High Limit	37	Set to desired max seed disc RPM.
Product Level Alarm		Sets the level to trigger an alarm alerting of low product levels. Entered value is an estimate in volume.
High Pop Alarm	15%	This is the percentage above the target population of the planter channel if rows are assigned to the planter channel. If rows are not assigned to a planter, this is the percentage above average planter population for all unassigned rows.
Low Pop Alarm	15%	This is the percentage below the target population of the planter channel if rows are assigned to the planter channel. If rows are not assigned to a planter channel, this is the percentage below average planter population for all unassigned rows.
Row Fail Rate	2/1 (2 seeds every 1 second)	Set to desired number of seeds per second to trigger seed sensor failure alarm.

Quick Setup Guide for IntelliAg Model YP1625 30" Twin Row Air Pro



STEP 5B: Material Configuration Setup (Ground Driven Metering)

For Ground Driven Metering, control channels 1, 3, and 4 **MUST** be disabled and the Monitor Only feature selected at the Control Setup screen.

NOTE: A Material Name must also be selected at the Row Monitor Setup screen to activate high and low population alarms.









1. At the Main Menu screen, press the Control Setup button .
2. Select and press one of the Material buttons (Material 1-16).
3. Enter desired values from **Table B2**.
4. Press the Control Setup button  to return to Control Setup screen.
5. Press the Channel Setup button  to proceed to Channel Setup screens and disable any active channels.

TABLE B2: Material Setup	Default Value/ Value to Enter	Ground Driven Metering Instructions/Definitions
Type	Monitor Only	Desired type of application control channel being used for a specific material.
Units	Ks/Ac S/Sec	Automatically changes with the type of material application selected. Changes units for target application.
Target Population	32.0	1000s of seeds per acre or hectare (32,000 seeds per acre)
High Pop Alarm		Warns of a high population problem. Values are % based.
Low Pop Alarm		Warns of a low population problem. Values are % based.
On/Off Pattern		Rows can be automatically turned ON or OFF according to the pattern.
Row Fail Rate	2/1 (2 seeds every 1 second)	Set to desired number of seeds per second to trigger seed sensor failure alarm.

STEP 6A: Planter Control Channel Setup (Controlled Hydraulic Drive)



1. At the Control Setup screen, press the Channel Setup button .
2. Select Channel 1 and verify that the channel is set to Planter Control.
3. Enter desired values using **Table C** as reference.
4. After planter control setup, calibrate hydraulic valve by pressing the Valve Cal button .
5. Ensure implement is raised. With brakes locked and transmission in PARK position, start engine.
6. Engage hydraulics and run engine at normal speed until hydraulic fluid is at operating temperature.
7. Verify point row clutches are turned ON.
8. **Do NOT perform this step unless meters are installed in all locations across planter row units or drive damage will occur.**
Press the START button . Turn the master switch to the ON position. The valve calibration will immediately start. Keep the hydraulics engaged until the calibration completes.
9. When the screen indicates calibration is complete, press the Channel Setup button  to return to Channel 1 home screen.
10. Turn the master switch OFF.
11. To set up additional control channels (planter or fertilizer control), press the Next Channel button .
12. Press the Work Screen button  when channel configurations are complete to return to the Main Work screen.

Once a control channel has been established as Planter Control, any new materials established as Planter Control on the Material Setup screen will automatically be added as optional materials for Planter Control channels on the Control Setup screen.

TABLE C: Planter Control Setup	Default Value/ Value to Enter	Instructions/Definitions
Type	Planter Control	Set desired Channel Type as Planter Control.
Material Name		Displays only materials that have been configured for the channel type.
Control Mode	AUTO	Auto is used in normal operating conditions calculating the rate of how the system is running. Manual mode acts as an override if application rate sensors are inoperable allowing the use of increase/decrease buttons to set the flow rate for the control. Refer to System Configuration section of Operator's manual for additional information.
Drive Type	PWM	A hydraulic valve varies the oil flow to the motor proportioned to the electric current supplied.
Drive Frequency	100 Hz	If not using a DICKEY-john supplied valve, see the manufacturer's specifications for drive frequency.
Input Filter	50	Feedback frequency filter for the control channel. DO NOT CHANGE.
Gear Ratio	1.900	Specifies the actual ratio from the feedback sensor to the seed meter shaft RPM. Number of revolutions the feedback sensor turns in relation to one revolution the seed meter turns.
Sensor Constant	360	Sensor Constant establishes the number of pulses for one revolution of the feedback sensor. If a DICKEY-john application rate sensor is used, the value should be set to 360.0.
# of Seed Rows	32	Entry of a specific number of seed rows for the control channel. Row assignment is given a priority based on the channel and will be assigned sequentially thereafter. Channel 1 is always assigned to the first set of rows, Channel 2 next set of rows, and so on.
Channel Width	480	Manual entry of the channel width for rows assigned to a specific channel. Width calculation can be determined by # of planter rows assigned to the channel multiplied by the row spacing.
Precharge Time	+ 0.0	Typically used during startup conditions in the field, a Precharge time is a specified length of time a control channel will operate at the defined Precharge Ground Speed. Must be entered as a positive (+) number.
Delay Time	- 0.0	Length of time before the control channel will start after the master switch has been turned ON and the implement switch is in a lowered position. Must be entered as a negative (-) number.

STEP 6B: Planter Control Channel Setup (Ground Driven Metering)

NOTE: When using a ground drive/nonhydraulic application to monitor population, control channels 1, 3, and 4 must be disabled and Material Setup configured for Monitor Only. A material name must also be selected on the Row Monitor screen.

1. Press the Channel Setup button .
2. Select Channel 1 and verify that the channel is set to Disabled.
3. Press the Next Channel button  to change control channels 3 and 4 to Disabled.

Quick Setup Guide for IntelliAg Model YP1625 30" Twin Row Air Pro



STEP 7A: Material Configuration Setup (Split Air Regulation)

It is recommended that when setting a control channel for split air, the material name be created as "Air" to eliminate confusion between the actual material and the control used.



1. At the Main Menu screen, press the Control Setup button .
2. Press Material button 16.
3. Enter desired values from **Table D**.
4. Press the Work Screen button  to return to the Main Work screen.

TABLE D: Material Setup	Default Value/ Value to Enter	Split Air Regulation Instructions/Definitions
Type	Split Air Reg	Desired type of application control channel being used for a specific material. CREATE MATERIAL NAME AS "AIR".
Units	In H ² O Oz in ²	Automatically changes with the type of material application selected. Changes units for target application.
Preset Method	Disabled	User-defined target rates can be configured and when enabled can be adjusted from the Main Work screen using the Increment/Decrement buttons.
Target Rate	2.00	Establishes the desired rate of application in inches of H ² O.
Max Rate	5.00	Maximum application rate in inches of H ² O.
Min Rate	1.00	Minimum application rate in inches of H ² O.
Inc/Dec %	5%	Percentage of change of the entered target rate applied each time the Increment/Decrement button is pressed on the Main Work screen.

STEP 7B: Planter Control Channel Setup

(Split Air Regulation)

NOTE: Split Air Regulation must be configured as Control Channel 2 only.



1. At the Control Setup screen, press the Channel Setup button .
2. Select Channel 2 and select Split Air Regulation as the Type.
3. Enter desired values from **Table E**.
4. Press the Work Screen button  to return to the Main Work screen.

TABLE E: Planter Control Setup	Default Value/ Value to Enter	Split Air Regulation Instructions/Definitions
Type	Split Air Reg	Configure Control Channel 2 as Split Air Regulation.
Control Mode	Auto	Control channel feedback based on air pressure sensor.
Drive Type	Air Reg 2	Automatically selects Air Reg 2 as drive type.
Input Filter	79	Amount of filtering applied to the control channel feedback frequency.
Pressure Drop	0	Difference in pressure sensor mounting location to the seed disk in inches of H ² O.
Pressure Slope	447.2269	The change in pressure sensor voltage to a frequency readable by the IntelliAg system and measured in inches of H ² O. Should only be adjusted by qualified personnel.
Pressure Offset	800	Takes a zero point reading that provides a frequency when the fan is off. Press the Zero Pressure button to calculate frequency.
Planter Selection	YP16	Select planter selection of YP1625 automatically adjusts to the appropriate calibration settings.
Sensitivity Adjust	0	Increases or decreases the calibration parameters in the ranges of -10 to +10. Increasing response time makes the system response quicker.

STEP 8: Row Monitor Setup



1. At the Main Work screen, press the Row Monitor button .
2. Enter desired values using **Table F** as reference.
3. Press the Work Screen button  to return to the Main Work screen.

TABLE F: Row Monitor Setup	Default Value/ Value to Enter	Instructions/Definitions
Material Name	See Instructions	Material Name only appears on the Row Monitor Setup screen when all control channels are disabled and material is set for Monitor Only. This is only used for ground drive/nonhydraulic applications to monitor population with high and low alarms. A material must be configured and selected to activate alarms.
High Alarm Delay	5	Desired number of seconds that high population can be above high alarm point before alarm will sound.
Low Alarm Delay	5	Desired number of seconds that low population can be below low alarm point before alarm will sound.
Population Adjust	100	Enter a % to allow for seed sensor population inaccuracies to achieve the desired population display. 100% represents true calculation.
Population Filter	50	Set filter value to stabilize the monitored population display. Number can be set to 0% for no filtering and 99% for high level filtering.
Row Fail Rate	2/1 (2 seeds every 1 second)	Set to desired number of seeds per second to trigger seed sensor failure alarm.

Quick Setup Guide for IntelliAg Model YP1625 30" Twin Row Air Pro



STEP 9: Speed Set Calibration Setup







1. At the Main Work screen, press the Speed Set button .
2. Enter desired values using **Table G** as reference.
3. Press the Work Screen button  when ground speed calibration configurations are complete to return to the Main Work screen.

TABLE G: Speed Set	Default Value/ Value to Enter	Instructions/Definitions
Source	Digital Frequency	Select CAN Ground if radar is connected to ISO tractor cab harness. Select Digital Frequency if radar or hall-effect is connected to WSMT actuator harness.
Gspd Constant	2546	Input based on pulse count produced by the ground speed sensor over 400' distance. See Operator's manual for calibration instructions.
Shutoff Speed	0.5 mph	Set desired minimum ground speed allowed before the system shuts off.
Minimum Override	2.0 mph	Set to operate when actual ground speed falls below the designated value. Control will operate at this speed until actual ground speed rises above minimum override speed or actual speed drops below shutoff.
Master Sw Timeout	10	Set to desired number of seconds system shuts off if the master switch is turned on and there is no ground speed. Toggle master switch to restart the system and turn off alarm.
Gspd Fail Alarm Delay	5	Set to desired number of seconds alarm sounds after the ground speed is zero and seed flow continues. (Monitor only)
Precharge Ground Speed	0	Set to the desired speed the system will use when a precharge time has been enabled for a control channel. Refer to Table C1: Planter Control Setup for Precharge Time. This setting will only display when a Precharge Time has been entered.
Implement Lift	Enabled	Implement lift switch, when enabled, displays an implement lift indicator on the Main Work screen indicating implement lift position as up or down. Control channels can be turned on and off without using the master switch.

STEP 10: Accessory Sensor Setup

Hopper Assignment

1. At the Main Work screen, press the Next Page button .
2. Press the Module Configuration button  to display the Module Configuration screen.
3. At the Module Configuration screen, press the Hopper Assign button .
4. Press Hopper Set button .
5. Enter desired values using **Table H** as reference.

RPM Assignment



6. At the Module Configuration screen, press the Accessory Assignment button .
7. Press the RPM Setup button . NOTE: There must be at least 1 RPM sensor configured before the RPM Setup button appears on the screen.
8. Enter desired values using **Table H** as reference.

TABLE H: Accessory Setup	Default Value / Value to Enter	Instructions/Definitions
Hopper Setup		
# of Hoppers	1 (base unit) 1 more (optional)	# of hopper sensors connected to each module (4 sensors maximum). # of hopper data items for each listed module and the Hopp #'s value will automatically populate if Auto Config is used to configure installed sensors.
Logic Level	Active Lo	Sets the active state to low signifying that an alarm is generated if the sensor's output is in a low state. Use this setting if the connected sensor outputs a low condition when empty similar to the DICKEY-john hopper sensor.
Alarm Delay	5 sec	Controls the delay time between the detection of a high/low hopper alarm condition and the generation of the resulting alarm. The value is entered in seconds.
Channel		Assigns hopper sensor to channel.
RPM Setup		
High Alarm (fan speed)	3000 rpm	Sets the RPM value at which a high RPM warning error is generated.
Low Alarm (fan speed)	1800 rpm	Sets the RPM value at which a low RPM warning error is generated.
High Alarm Delay	10 sec	Establishes the delay between the detection of a high RPM alarm condition and the resulting alarm display. The value is entered in seconds.
Low Alarm Delay	10 sec	Establishes the delay between the detection of a low RPM alarm condition and the resulting alarm display. The value is entered in seconds.
RPM Constant	3 pulses/rev	Number of pulses per sensor revolution.
RPM Filter	0	Filters the signal out of the RPM sensor.
Disable Control on Low Alarm	Disabled	Allows for disabling of all control channels if the RPM value of the selected sensor falls below the low alarm level setting.

Quick Setup Guide for IntelliAg Model YP1625 30" Twin Row Air Pro



STEP 11: Clutch Folding Module (CFM) Setup

The CFM is installed in the cab to control row clutches, marker, fold, fertilizer on/off, lift and hitch.

1. At the Main Work screen, press the Clutch CFG button to access the Clutch Configuration screen and verify that the correct # of clutches are configured for the system.
2. The Clutch CFG button  only appears as a top level button when a planter output module and clutch folding module are installed.

 # of Clutches 2



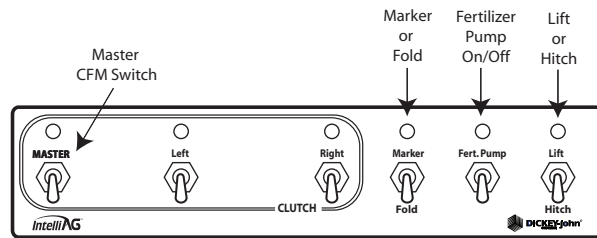

OUTPUT	# OF ROWS	ROW #'s
LEFT	16	1-16
RIGHT	16	17-32

STEP 12: Clutch Folding Module Operation

1. The planter section controls turn the left and right clutch controls on and off.
2. The master switch must be in the ON position to activate any planter section. When a clutch control is ON, a green light will illuminate.
3. Marker/Fold Switch should be in the UP (Marker) position during planting. In the DOWN (Fold) position, the switch controls the fold of the main frame.
4. The fertilizer pump switch is turned ON when in the UP position. Press the switch in the DOWN position to turn OFF.
5. Lift/Hitch switch should be in the UP (Lift) position during normal operation. In the hitch position, the switch should be in the DOWN (Hitch) position to unlock and extend the telescoping tongue in preparation of folding the implement for transport.
6. Lift/Hitch switch **MUST** be in the hitch position and hydraulic circuit in FLOAT when transporting planter equipped with hydraulic-operated tongue hitch. **NOTE:** Lift/Hitch switch has no function if planter has standard 3-point hitch operated tongue hitch.





STEP 13: 5 Revolution Test

1. Press the Control Setup button .
2. Press the Channel Setup button .
3. Press the Next Page button .
4. Ensure implement is raised before starting 5 Rev Test.
5. With brakes locked and transmission in PARK position, start tractor engine.
6. Engage hydraulics and run engine at normal speed until hydraulic fluid is at operating temperature.
7. Press the 5 Rev button .
8. Test Ground Speed and Row data must be entered to perform test.
9. Press and hold remote test button to initiate 5 Rev Test.

STEP 14: Summary Screen

The Summary screen provides an overview of setup constants for active control channels.

1. At the Main Work screen, press the Next Page button .
2. Press the Summary button .
3. To view specific control channel configurations, press the respective control channel box 1-4.
4. Press inside a yellow highlighted box to open a specific screen for editing.
5. Press the Work Screen button  to return to the Main Work screen.

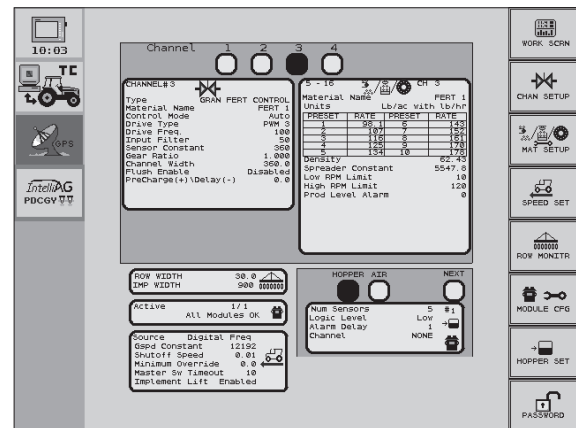

Summary Screen

Quick Setup Guide for IntelliAg Model YP1625 30" Twin Row Air Pro

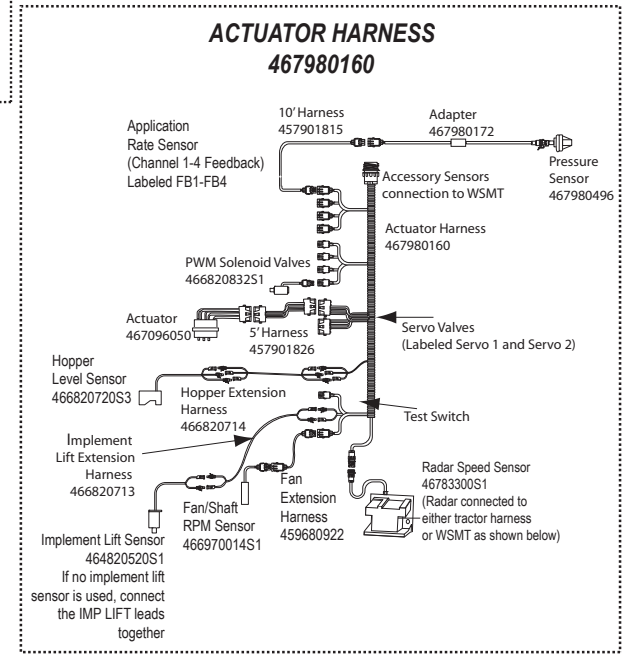
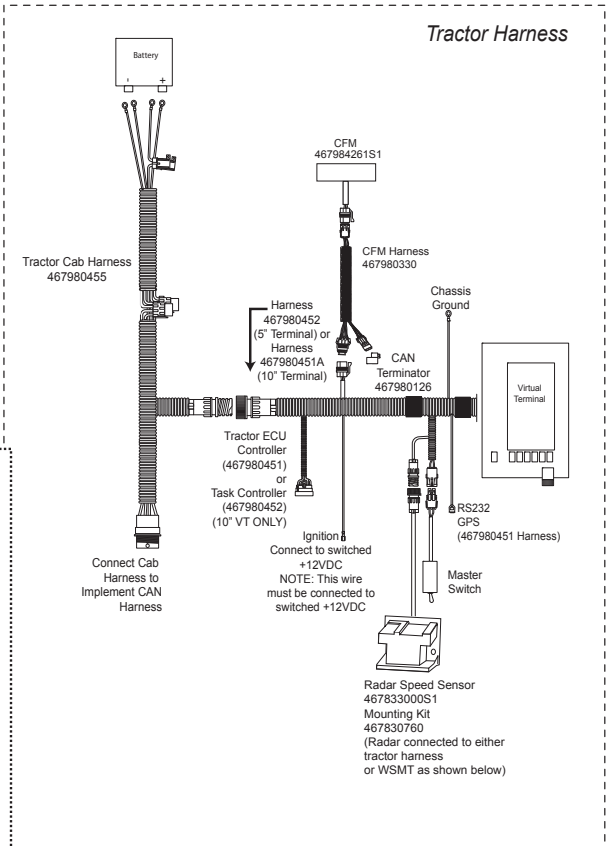
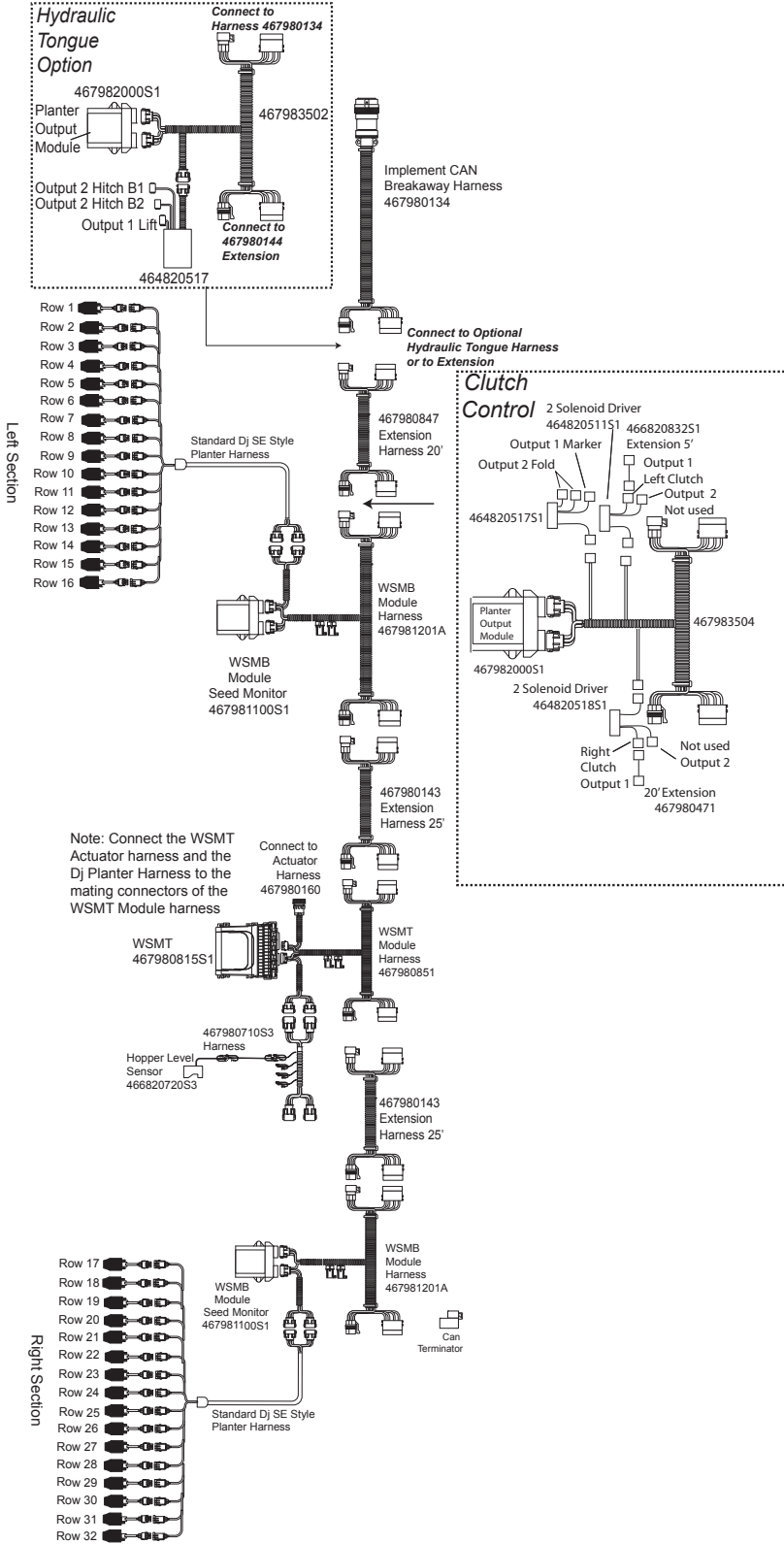

System Component Installation

1. Locate and install system components as shown in the diagram. Note how the modules are identified and which modules are located on which sections in this system.
2. Connect WSMB module harnesses together with included extensions. Modules connect to the WSMT harness connection. Plug all unused connectors with included dust plugs.
3. Secure any excess wires with tie-wraps.
4. See Operator's Manual for additional installation information.
5. Power on monitor and program with correct constants as described on this Quick Start Guide.